

TECHNICAL DATA SHEET

BauderSOLAR F XL flat roof photovoltaic mounting system for larger format modules

BauderSOLAR F XL is a flat roof PV mounting solution for framed solar modules. The mounting units are secured to the roof using a unique membrane-to-membrane welding technique. This installation method means that the roof is not compromised by penetrations for fixings, nor does it require additional ballast, which would add additional weight loading to the roof.

Intended Use

BauderSOLAR F XL is specifically designed to be installed on specific Bauder bituminous or single ply waterproofing systems and provide a lightweight, low risk and quick to install mounting solution for larger format framed solar modules manufactured by our module partners.

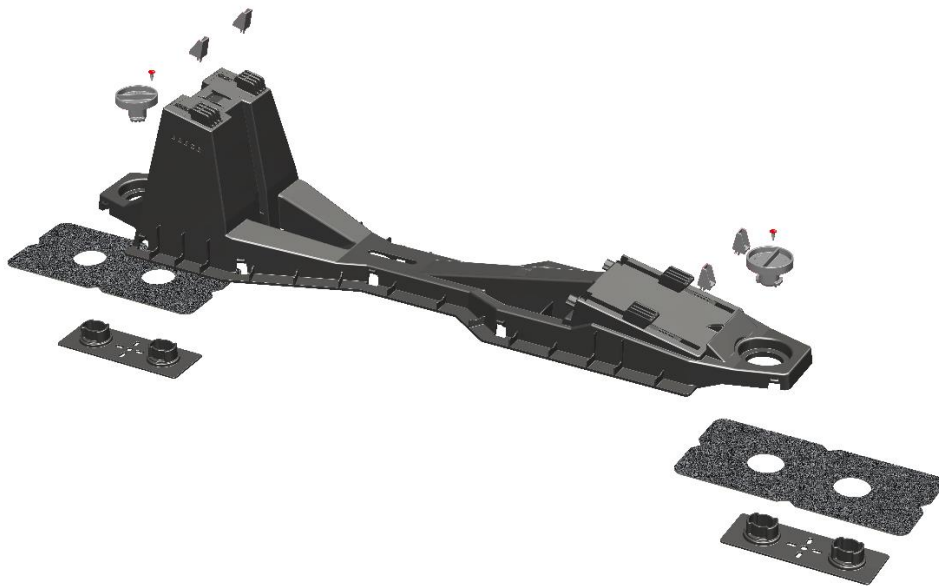













UNITED KINGDOM

Bauder Ltd
70 Landseer Road, Ipswich, Suffolk IP3 0DH
T: +44 (0)1473 257671 E: info@bauder.co.uk
bauder.co.uk

IRELAND

Bauder Ltd
O'Duffy Centre, Carrickmacross, Co. Monaghan
T: +353 (0)42 9692 333 E: info@bauder.ie
bauder.ie

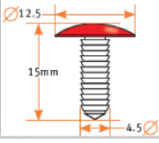
TECHNICAL DATA SHEET

No.	Sketch	Name	Quantity	Description	Recycling
1		BauderSOLAR F XL main substructure	1 Pcs	Substructure with integrated module clamps (Polypropylene PP)	
2		BauderSOLAR MST-BIT welding sleeve	Subject to design	Welding sleeve for welding to Bauder bitumen roof membranes	EWC number 170302 (bitumen)
2		BauderSOLAR MST-PVC welding sleeve	Subject to design	Welding sleeve for welding to Bauder Thermofol PVC roof membranes	EWC number 170203 (PVC)
2		BauderSOLAR MST-FPO welding sleeve	Subject to design	Welding sleeve for welding to Bauder Thermoplan FPO roof membranes	EWC number 170203 (FPO)
3		BauderSOLAR GF Baseplate	Subject to design	Receivers for the bayonet twist lock fitting (Polyamide PA6-GF30)	
4		BauderSOLAR BJT bayonet Cap	2 Pcs	Twist lock for locking to the base plate (Polyamide PA6-GF30)	
5		BauderSOLAR MDS locking Pin	4 Pcs	Module securing device with two snap-in hooks below (Polypropylene PP)	
6		BauderSOLAR BSP Bayonet Safety Pin	2 Pcs	Push fit pin to lock Bayonet Cap in place (Nylon)	

PRODUCT INFORMATION AND TECHNICAL PERFORMANCE

Characteristic	Test method	Unit	Value
Weight	EN 1848-1	kg/m ²	9 to 12.5*

* Includes weight of solar module, variable depending on module type and system layout.

UNITED KINGDOM

Bauder Ltd
70 Landseer Road, Ipswich, Suffolk IP3 0DH
T: +44 (0)1473 257671 E: info@bauder.co.uk
bauder.co.uk

IRELAND

Bauder Ltd
O'Duffy Centre, Carrickmacross, Co. Monaghan
T: +353 (0)42 9692 333 E: info@bauder.ie
bauder.ie

TECHNICAL DATA SHEET

CERTIFICATION AND ENVIRONMENTAL INFORMATION

International Standards Organisation (ISO)	ISO 9001:2015 Quality Management Certificates EN1271 (UK) and 70499/03-15_e (Germany).
	ISO 14001:2015 Environmental Management Certificates A10552 (UK) and 70499/03-15_d (Germany).
	ISO 50001: 2011 Energy Management Certificate 70499/03-15_c (Germany)

INSTALLATION GUIDANCE

BauderSOLAR F XL is designed to be installed by a Bauder approved and trained contractor only. Please see BauderSOLAR installation guidelines for a full breakdown of the system installation methodology.

The number of mounts and fixings required will vary from project to project. Please contact Bauder for a project specific technical report for further information. Windload and snowload calculations will also be provided on a project specific basis.

BauderSOLAR F XL can be installed on slopes of up to 5° for bituminous membranes and 10° for single-ply membranes.

BauderSOLAR F XL is intended to be used in combination with the following membranes:

- Bauder Total Roof System
- Bauderflex
- Bauder Thermofol – minimum 1.8mm mechanically fixed or adhered, all colours*
- Bauder Thermofol Fleece Back – minimum 1.5mm mechanically fixed or adhered, all colours*
- Bauder Thermoplan – minimum 1.5mm mechanically fixed, all colours

BauderSOLAR F XL is compatible with modules that meet the following criteria:

Module Length = ca. 2000mm maximum
 Internal frame (B-B) = 979mm-1080mm
 Module depth (E-E) = minimum 25mm
 Module flange width (C-C) = Minimum 10mm

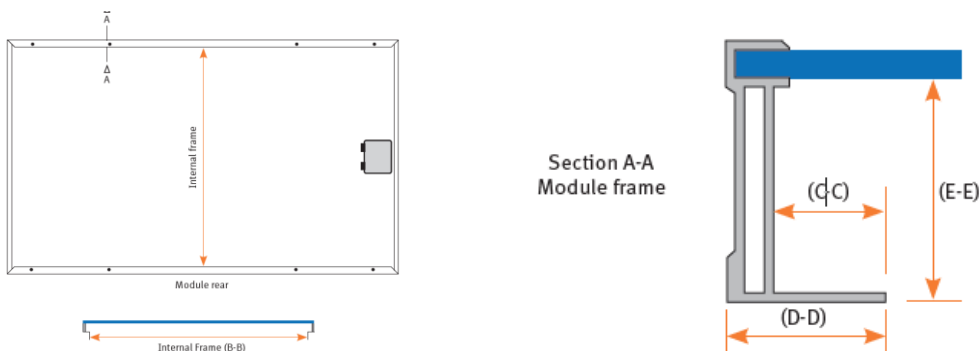

Specific test standards and results are stated in Bauder product datasheets and our specification service should be used to confirm suitability to each individual project.

Bauder reserves the right to update this data set without prior notice and this document is uncontrolled if printed or stored. Always confirm the latest version is used for the adoption of this product, available from our website: bauder.co.uk/technical-centre.

Intended use of this product should be verified with Bauder to ensure suitability and compliance with applicable guidance, regulations, legislations, project requirements, specifications, and installation techniques.

UNITED KINGDOM

Bauder Ltd
 70 Landseer Road, Ipswich, Suffolk IP3 0DH
 T: +44 (0)1473 257671 E: info@bauder.co.uk
bauder.co.uk

IRELAND

Bauder Ltd
 O'Duffy Centre, Carrickmacross, Co. Monaghan
 T: +353 (0)42 9692 333 E: info@bauder.ie
bauder.ie